



User Manual

Sliding Gate







eSSL-HG-1500





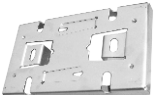

WARNING TO THE INSTALLER AND USER

- 1) CAUTION! For personal safety it is important to follow all the instructions carefully. Incorrect installation or misuse of the product may cause serious harm to people .
- 2) Keep the instructions in a safe place for future reference.
- 3) This product was designed and manufactured strictly for the use indicated in this document. Any other usage not expressly indicated in this Document, may damage the product and/or be a source of danger.
- 4) BS accepts no responsibility due to improper use of the automatic machine (opener) or use other than that intended.
- 5) Do not install the machine in an area subject to explosion hazard. Inflammable gasses or fumes are a serious safety hazard.
- 6) BS will not accept responsibility if the rules of good workmanship are disregarded in installing the closing elements to be motorised, if any deformation occurs during use of the said elements.
- 7) Before carrying out any work on the system, turn off the electricity supply.
- 8) The safety devices(e.g.photocells,sensitive edges, etc...) may be used to prevent any potential risk in dangerous areas where the moving mechanism is located , such as crushing, dragging, or shearing.
- 9) BS accepts no responsibility regarding safety and correct operation of the machine, should components made by manufacturers other than we be used in the system.
- 10) Do not make any alterations to the components of the automatic machine (opener and accessory).
- 11) The installer must supply full information regarding operation manual of the system in the event of any emergency and provide the system user with the "INSTRUCTION" included with the product.
- 12) Do not allow children or other people to stand near any moving part of the opener or door construction while in operation.
- 13) Keep transmitters away from children to prevent the machine from being activated accidentally.
- 14)The user must refrain from attempting to repair or adjust the system personally and should only contact professional personnel .
- 15) Frequently examine the installation, in particular check cables, springs and mountings for signs of wear, damage or imbalance .Do not use if repair or adjustment is needed since a fault in installation or an incorrectly balanced door may cause injury.

- 16) This appliance is not intended for use by persons (including children) with reduced physical, sensory or mental capabilities, or lack of experience and knowledge, unless they have been given supervision or instruction concerning use of the appliance by a person responsible for their safety.
- 17) If the supply cord is damaged, it must be replaced by the manufacturer, its service agent or similarly qualified persons in order to avoid a hazard.
- 18) Disconnect the supply when cleaning or other maintenance is being carried out, if the appliance is automatically controlled.
- 19) The temperature range marked on the drive should be suitable for the location.
- 20) The electrical cord plug must plug in indoor outlet or waterproof cover outlet.

1. Introduction

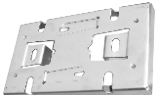
<p>BS-IZ-I Complete kit</p>	 <p>Release key</p>	 <p>Limit stopper</p>	 <p>BS-IZ-I</p>
 <p>Transmitters</p>	 <p>Base plate</p>	 <p>Accessories</p>	

<p>BS-IZ-II Complete kit</p>	 <p>Release key</p>	 <p>Limit magnet/ Bracket</p>	 <p>BS-IZ-II</p>
 <p>Transmitters</p>	 <p>Base plate</p>	 <p>Accessories</p>	

1.1 Dimension

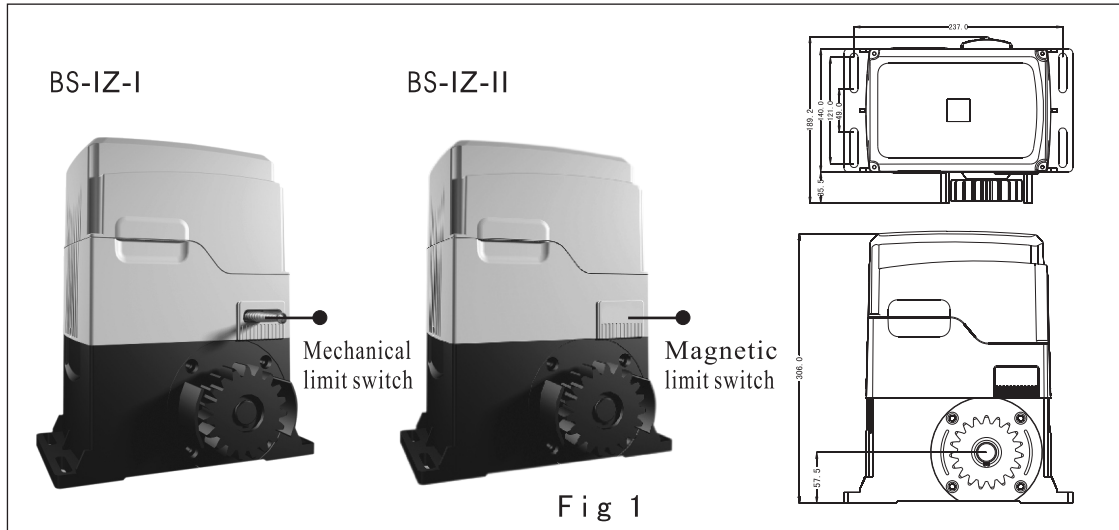

- * Built-in control board.
- * Terminals for Push button, Photocell, Alarm lamp.
- * Auto-closing is available, time delay is adjustable.

1.2 Technical Specifications

Model	BS-IZ 1000	BS-IZ 1500
Power supply	220V/50Hz or 110V/60Hz	
Motor power	370W	450W
Absorbed current	3A	
Motor rotational speed	1400r/min	
Thermal protection on motor winding	120°C	
Ambient temperature	-20°C ~ 55°C	
Max weight of gate	≤ 1000kg	≤ 1500kg

2. Installation

- * Before using the machine, check power supply, grounding, voltage, etc.
- * Check whether it is connected according to the demand of wiring diagram.
- * The gate should be pulled easily and smoothly manually when the worm gears are released.
- * The worm gears will be coupled before power on.
- * The product must be installed by professional person.

2.1 Example of a sliding gate operator installed

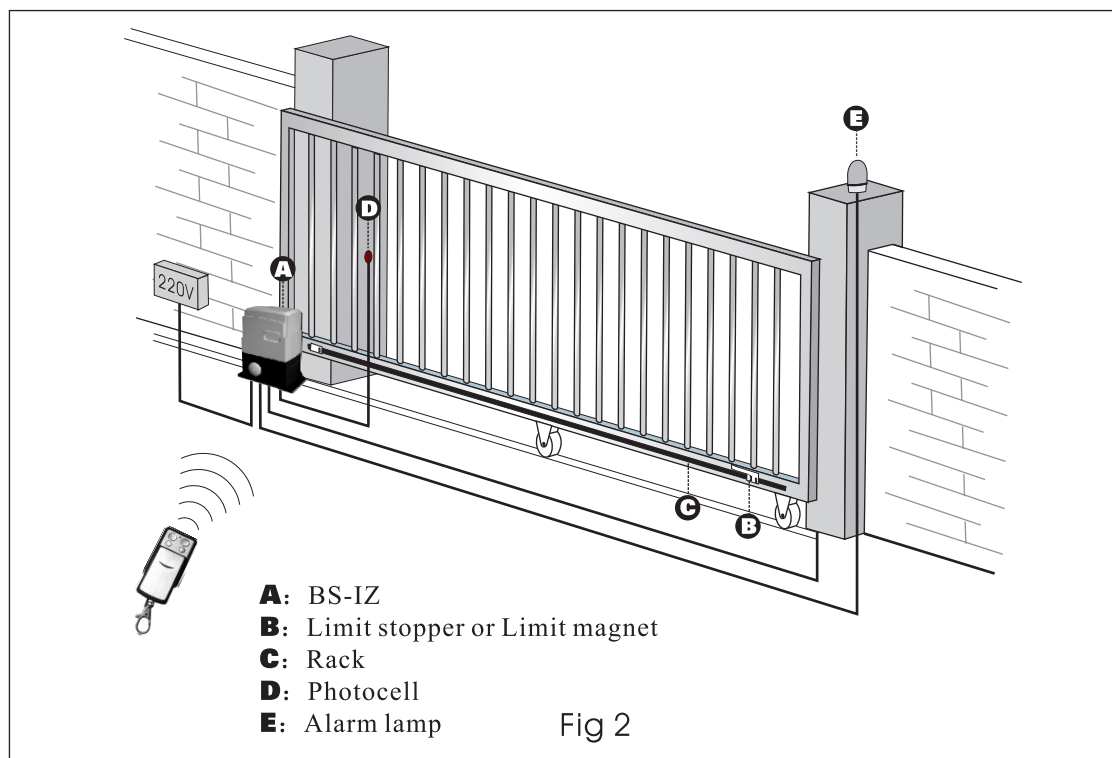

2.2 Installation and adjustment

2.2.1 Install baseplate on the ground, then, fasten the sliding motor on the baseplate.

Key: Ensure baseplate on level position.

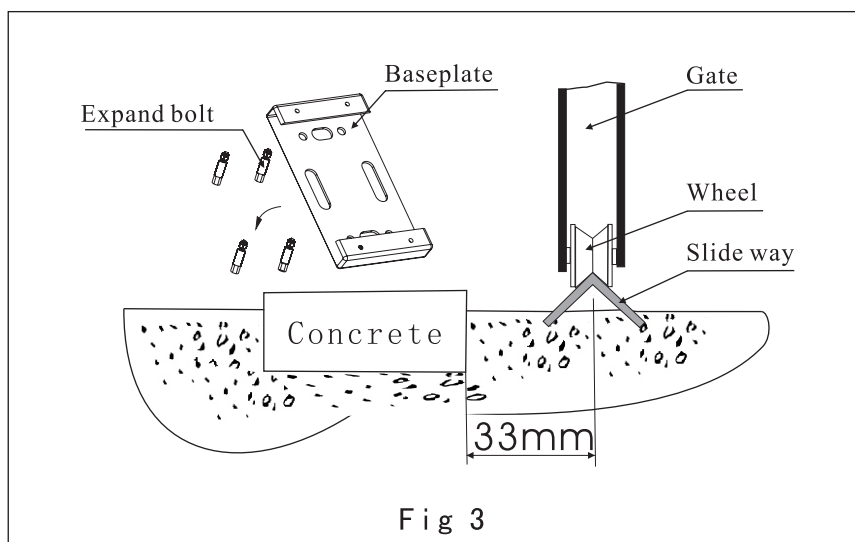

2.2.2 Install the limit stopper or limit magnet at proper position on the steel rack.

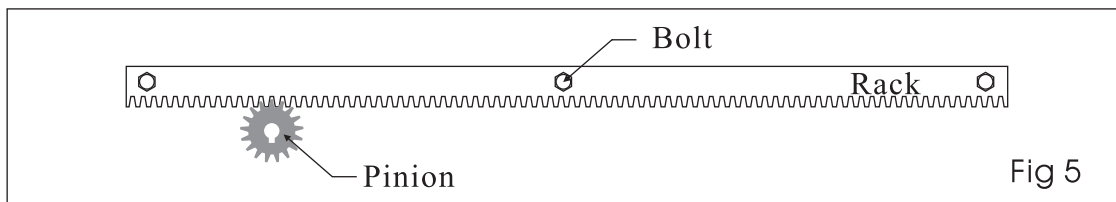
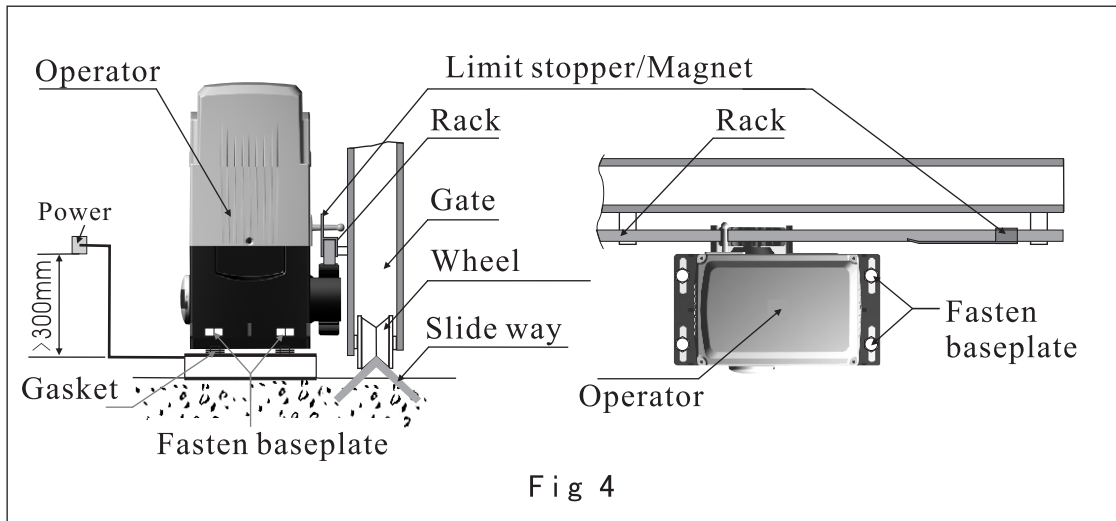

Before place the limit stopper or magnet on the rack, the gear box of the operator must be released. As per Fig 6A or fig 6B, Use the key turn clockwise to release the gear.

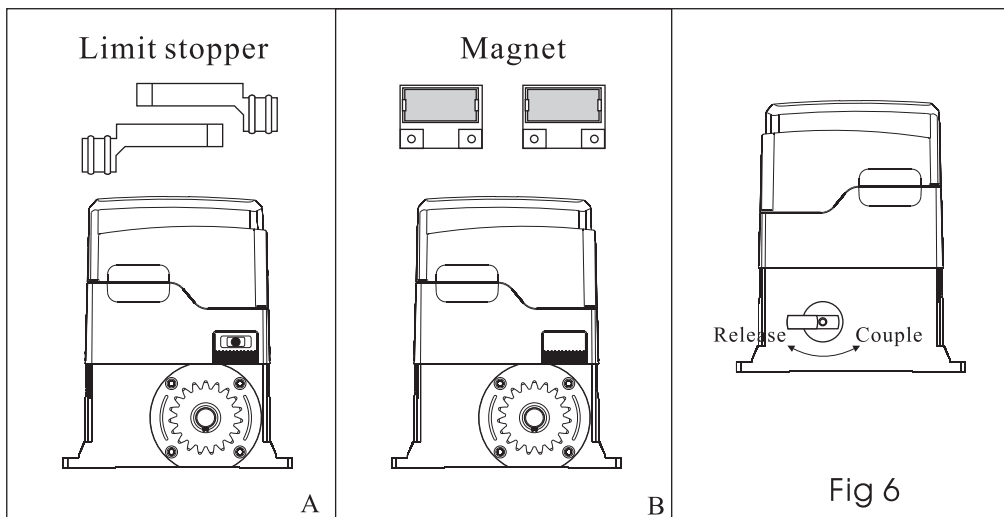

Move the gate manually to the open limit and close limit, mark the points on the Rack, then, fix the limit Stoppers or Magnets at the limit points on the Rack.

When the Operator is installed on Left Side.

Close Limit stopper or Magnet

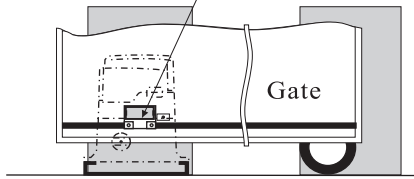

Closed state

Open Limit stopper or Magnet

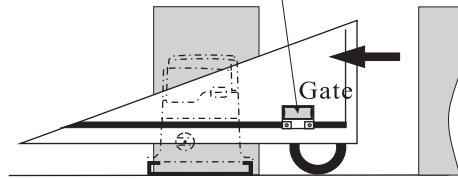

Open state

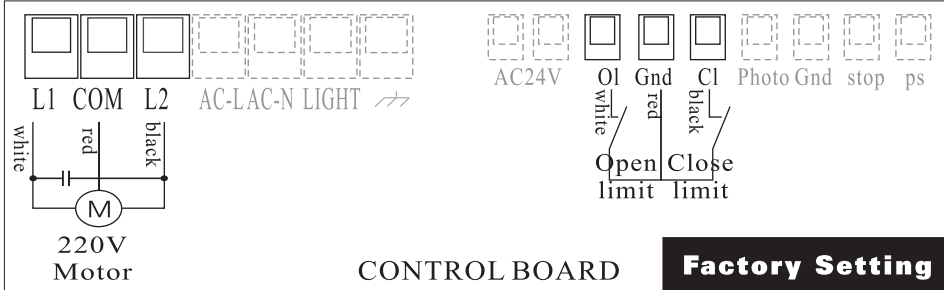

When the Operator is installed on Right Side.

Close Limit stopper or Magnet

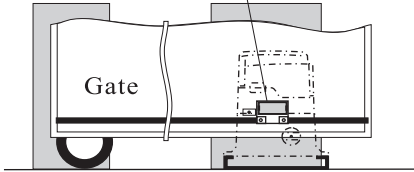

Closed state

Open Limit stopper or Magnet

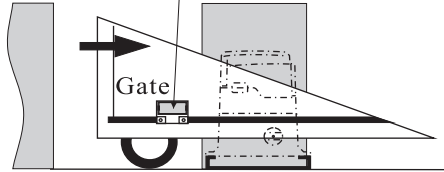

Open state

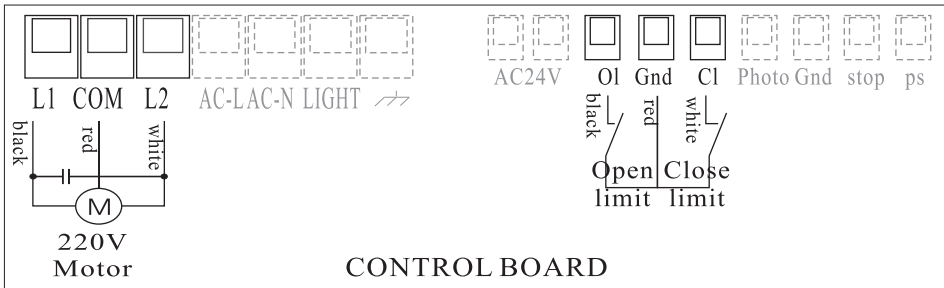
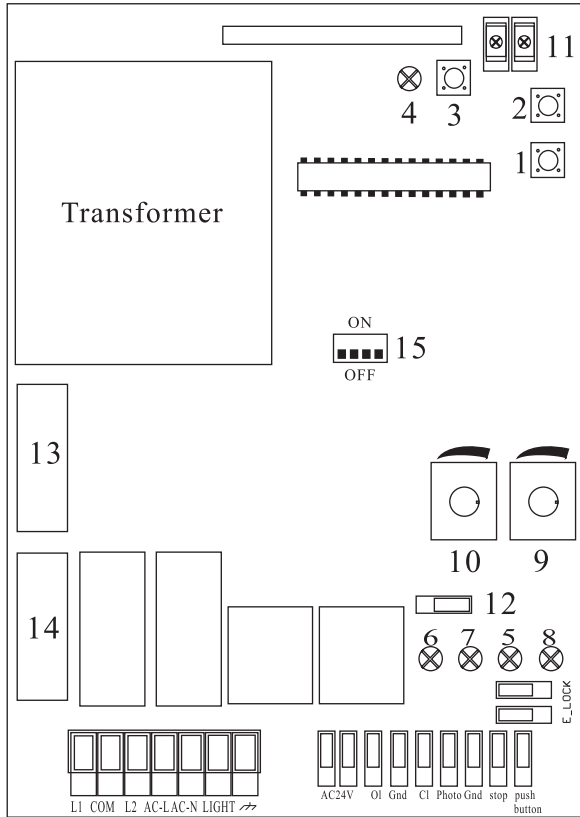

Fig 7

NOTE: Magnet must be 10mm~20mm space from the operator, and must be same height with the Magnetic switch inside of the Operator.

3. Control Board

3.1 Layout of PCB and Definition



1. P1: Set running time
2. P2: Set auto-Closing delay time
3. S1: Set transmitter
4. LED1: Set transmitter LED
5. LED2: Running state LED
6. LED3: Open limit LED
7. LED4: Close limit LED
8. LED5: Power LED
9. VR1: Adjust power of motor
10. VR2: Adjust resistance of obstacle
11. J3: Terminal for Antenna
12. J4: Jumper for reverse function
(ON: valid)
13. F1: Fuse for transformer (0.2A)
14. F2: Fuse for motor (10A)
15. S4: DIP switch for function choice

3.2 Diagram

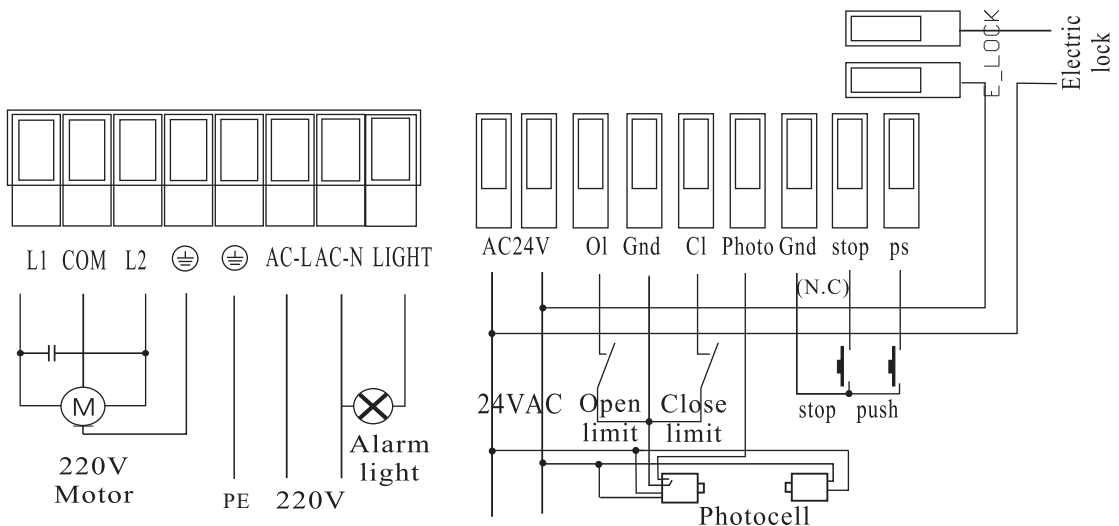

3.3 Set running time: _____

After finish the installing and connecting, Power on, and Press "**P1**" for 3 second, the gate will open and close at the limit point one cycle, the running time is remembered by the control system.

If no limit stopper or limit magnet on the rack, you also can press "**P1**" when the gate open and close to the right limit points.

DIP3: ON, Soft stop

DIP4: ON, Soft start

3.4 Set Auto-closing delay time: _____

When the motor is stand-by, Press "**P2**" for 3 second, LED2 lighten, time-counter starts, then Press "**P2**" again after the need delay time. LED2 is out , delay time is set.

DIP1: ON, Auto-closing

3.5 Set Reverse function: _____

Try to adjust VR2 again and again till the sensitivity is exact to reverse when the running gate meets obstacle.

3.6 DIP switch programming _____



DIP1:

ON: Auto-closing is valid

OFF: Auto-closing is invalid

DIP2:

ON: When the gate is running to close, press button on transmitter, the gate open immediately

OFF: Single button control and "Step-by-Step" mode carry out "Open-Stop-Close-Stop-Open"

DIP3:

ON: soft stop

OFF: No Soft stop

DIP4:

ON: soft start

OFF: No Soft start

3.7 Transmitter's code setting

Press "LEARN BUTTON", the "LEARN LED" light, then, press the button which you choose on the transmitter till the "LEARN LED" flash and go out, Now, the transmitter is coded. Other transmitters can be coded as this way

Specification maybe changed without a prior notification.

3.8 Erasing the transmitter's code

Erasing transmitter codes: Press "LEARN BUTTON" and hold on to make the "LEARN LED" light till go out. Now, all codes of transmitters which had been learnt are cleared.

4. Trouble Shooting

Number	Trouble	Cause	Shooting
1	motor can not work	<ul style="list-style-type: none"> *No power supply *Break fuse * capacitor decay *Surpass load *Effected by the thermal protection 	<ul style="list-style-type: none"> *Check power supply *Change fuse *Change capacitor *Check if any barrier on track *Restart after 20 minutes
2	Can open (close) but can not close (open)	<ul style="list-style-type: none"> *Position of limit switch is not correct *Limit switch is damaged *whether L1\COM\L2 wires are connected wrong *Magnetic-steel dropped and position isn't right 	<ul style="list-style-type: none"> *Adjust position *Change limit switch *Connect correctly according to wiring diagram *Re-adjust magnetic-steel position
3	can not locate accurately	<ul style="list-style-type: none"> *Distance of limit switch is too large * limit switch is *whether COM、CLOSE、OPEN were connected *magnetic-steel' s position is wrong 	<ul style="list-style-type: none"> * Adjust position of limit switch *Change limit switch *Connect correctly according to wiring diagram *Re-adjust the position
4	Release device	<ul style="list-style-type: none"> *Operating handle is broken * Worm gears are jammed 	<ul style="list-style-type: none"> *Change the handle *Rotate the pinion
5	Push the "open" button but the gate close	<ul style="list-style-type: none"> * whether L1\L2 wires are connected wrong 	<ul style="list-style-type: none"> *Connect correctly according to wiring diagram
6	Motor can turn but can not work	<ul style="list-style-type: none"> * Compression spring of clutch is dead * Gear box is released 	<ul style="list-style-type: none"> * Change the spring * Couple the worm gear

